

Technical data sheet

Empty housing X 16 with hat profile rail

Item number: 2005568

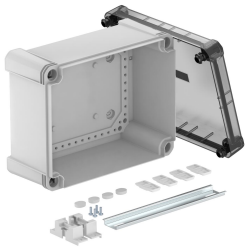

Junction box with hat profile rail for the connection of cables and lines indoors and in outdoor areas. Rectangular design without entries. Suitable for wall and ceiling mounting with the option to fasten outside, inside or to mount via the corner domes. Particularly impact resistant with IK09. Transparent cover with quick lock, sealable. Made from halogen-free and UV-resistant materials.

With hat profile rail 2069 and fastening set.

Junction box according to DIN EN 60670. Impact resistance IK09 according to DIN EN 50102. Protection rating IP67 according to DIN EN 60529.



PC Polycarbonate

Master data

Item number	2005568
Type	X16C R LGR-TR
Description 1	Empty Enclosure
Description 2	with trans. lid, rail 2069
Manufacturer	OBO
Dimension	240x191x125
Colour	Grey / transparent
Material	Polycarbonate
Smallest sales unit	1
Unit of quantity	Piece
Weight	87.3 kg
Weight unit	kg/100 pc.
CO2 Footprint (GWP) Cradle-to-Gate	3,2965 kg CO2e / 1 Piece

Technical data sheet

Empty housing X 16 with hat profile rail

Item number: 2005568



Dimensions



Length	241 mm
Width	191 mm
Height	126 mm

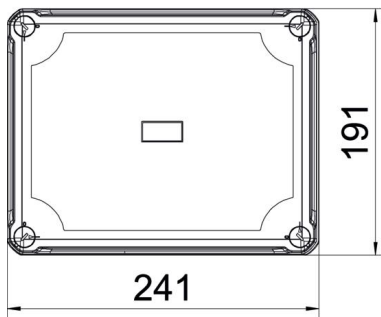

Technical data

Extension option	no
Equipment	Support rail
Cover fastening	Screwed
Shape	Rectangular
Suitable for outdoor use	yes
Clear internal dimensions with lid	227x177x110 mm yes
Mounting type	Surface-mounted
Protection rating	IP67
Protection rating IK code	IK09
Protection class	II
Permitted temperature range, max.	60 °C
Permitted temperature range, min.	-5 °C
Transparent lid	yes
Weatherproof	yes