

Technical data sheet

Universal counter-trough, plastic

Item no. 1198046



Regardless of the type of rail, the counter-trough can be used by applying it onto one side of the clamp clip. Due to an intelligent contour on the backside, the counter-trough can be combined to a double trough. Retrofitting possible without the need to dismantle.



PP Polypropylene

Master data

Item no.	1198046
Type	2058UW 46 LGR
Description 1	Counter-trough
Description 2	combinable with double trough
Available from	15.05.2019
Dimension	40-46mm
Colour	Light grey
RAL number	7035
Material	Polypropylene
Material symbol	PP
Smallest sales unit (VG)	50 Piece
Weight	0,65 kg/100 pc.

Technical data

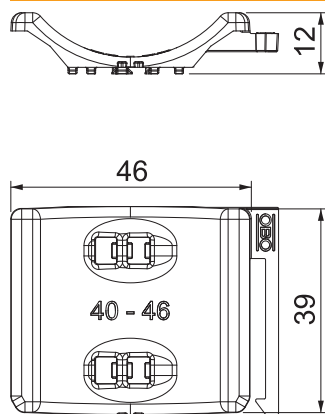

Dimension B	51,50 mm
Dimension H	11,80 mm
Dimension L	40,00 mm
Counter-trough/clip version	Counter-trough
Suitable for max. cable diameter	46,00 mm
Clamping range D	40,00 - 46,00 mm