

Technical data sheet

Clamp clip 2056 W-foot, 1-fold, plastic pressure sleeve, A2

Item number: 1187802



Clamp clip with W-foot, plastic pressure sleeve made of polypropylene. For vertical and horizontal mounting of 1 single cable on angle irons < 40 mm. With 1-start screw thread on pressure sleeve, universal hexagonal screw head WAF10, with slot and cross recess. Suitable for assembly indoors and outdoors. We recommend the use of a counter-sleeve.



A2 Stainless steel

2B Bright, treated

Master data

Item number	1187802
Type	BS-W1-K-12 A2
Description 1	Clamp clip 2056
Manufacturer	OBO
Dimension	08-12mm
Material	Stainless steel
Surface	Bright, treated
Surface standard	
Smallest sales unit	100
Unit of quantity	Piece
Weight	4.305 kg
Weight unit	kg/100 pc.

Technical data sheet

Clamp clip 2056 W-foot, 1-fold, plastic pressure sleeve, A2



Item number: 1187802

Dimensions

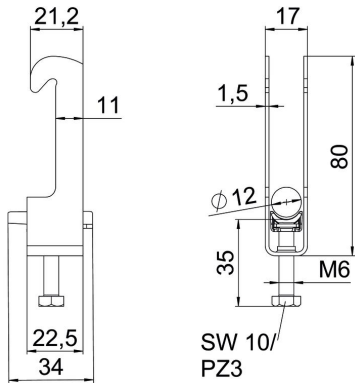

Length	22.5 mm
Width	17 mm
Height	80 mm
Plate thickness	1.5 mm
Dimension A	22.5 mm
Dimension B	17 mm
Dimension C	34 mm
Dimension G (mm)	M6
Dimension H	80 mm
Dimension L	35 mm
Dimension t	1.5 mm

Technical data

Number of cables/pipes	1
For pipe diameter, max.	12 mm
For pipe diameter, min.	8 mm
Thread	M6
Halogen-free	yes
Length of external dimensions	34 mm
Max. Tightening torque	3 Nm
With plastic trough	yes
Mounting type	Angle profile
Slot width	10 mm
Clamping range D, max.	12 mm
Clamping range D, min.	8 mm
Surface addition	Untreated
Material addition	Rustproof steel
With counter-trough	no
Material of trough	Plastic
Material quality of trough	Polypropylene